

technetix

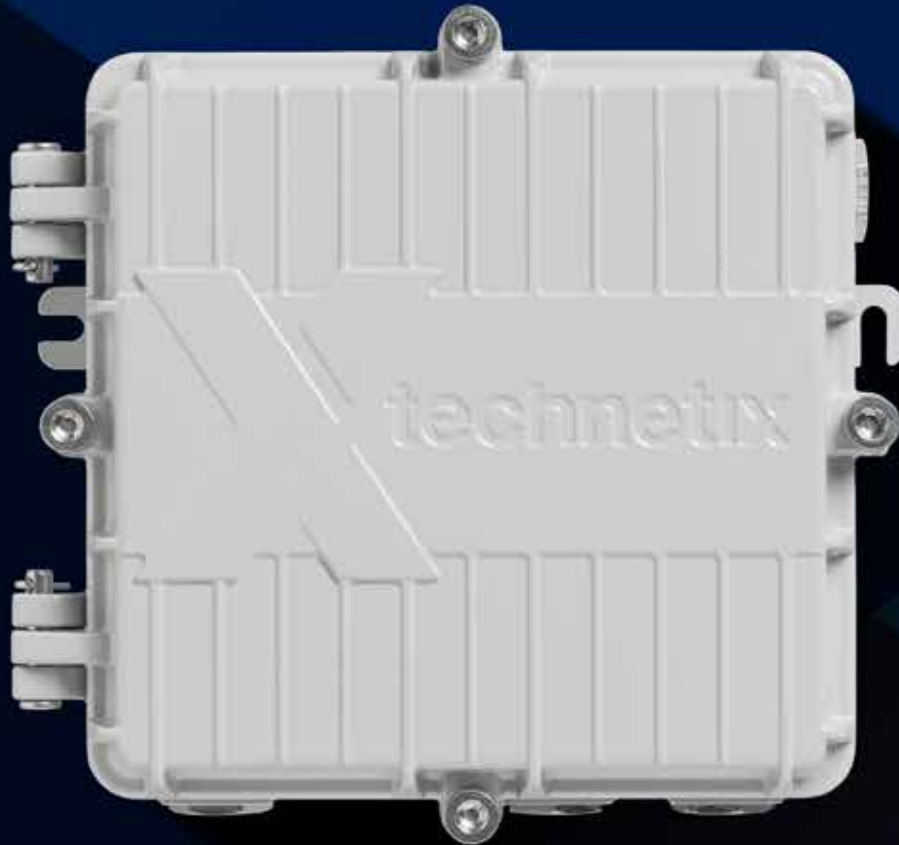

DBC-1200 Lite

User manual

customer.service.vdl@technetix.com

technetix.com

+31 318 58 59 59

Contents

Safety	3
Intended audience	3
Tools list	3
Installing the configuration software	4
Plug-in modules available for the DBC-1200 Lite	5
Chapter 1 Overview of the DBC-1200 Lite	6
Chapter 2 RF amplifier	7
Chapter 3: Installing the DBC-1200 Lite	8
3.1 Housing mounting	8
3.2 Installing coaxial (RF ports)	9
3.3 Closing amplifier lid	10
3.4 Power supply	11
3.5 Powering up the amplifier	11
3.6 Output diplexer shield transfer for the DBC-1200 Lite	12
3.7 Hardware and plug-in installation	13
3.8 Programming and alignment	16

SAFETY

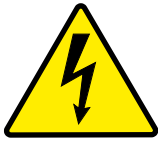

Caution: This symbol indicates that AC voltages: 35-65 VAC sine wave and 42-90 VAC square wave and 110/230 VAC may be present when power is connected to the DBC-1200 Lite. Please observe all notes and cautions in this user guide.

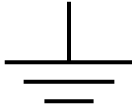

Caution: This symbol indicates a protective ground terminal.

The DBC-1200 Lite User Manual is intended for network engineers and technicians responsible for planning, configuring, installing and testing the Technetix DBC-1200 Lite amplifier. Installers should have a working knowledge of coaxial cable systems and cabling practices.

Tools list

The following tools and supplies are required when installing a DBC-1200 Lite:

- 6 mm hex key for the lid bolts
- Torque (6 Nm) limiting spanner (wrench) with hex-bit holder
- For exchanging diplex filters: DBx diplex removal tool DBGB-A-1 (19011053)
- Appropriate bolts/screws/washers for mounting the DBC-1200 Lite (see Chapter 3: Installing the DBC-1200 Lite)
- Appropriate USB cable and application for the setup of the DBC-1200 Lite



PRODUCT INFORMATION: USB cables and interfaces available:
19005966 USB A micro OTG (10cm – micro USB) for use with BLA
19010840 USB A-male to A-male 5M for use with BLL
19011053 DBx diplex removal tool

Installing the configuration software

- Configuring with Windows laptop:
 - Install BLL application
 - Connect PC and amplifier with USB A male to USB A male
- Configuring with Android phone or tablet:
 - Connect phone and amplifier with above USB cable and with USB OTG adapter (connected to a phone)
- Configuring with t-box (WiFi communication):
 - Appropriate USB cable is provided with t-box

The software required to configure a DBC-1200 Lite is dependent on the device used to connect to the modules within the amplifier:

- Laptop – BLL software. This software requires the Windows OS. The latest BLL software can be found on our website: www.technetix.com

Installation requires a password that can be obtained from your sales representative.

For detailed installation and use of the BLL software refer to the BLL user manual.

- Android – BLA software. The software requires Android version 4.1 or higher and USB host.

The latest BLA app can be found on our website: www.technetix.com

Installation requires a password that can be obtained from your sales representative.

For detailed installation and use of the BLA app refer to the BLA user manual.

Optional t-box allowing wireless configuration using a laptop , Android device or IOS.

DBC-1200 Lite ordering information

Item code	Description
19012464	DBC-1200 lite 1.2 GHz, 44 dB, 230 VAC 85/102 MHz diplex split
19012462	DBC-1200 lite 1.2 GHz, 44 dB, 65 VAC 85/102 MHz diplex split
19012463	DBC-1200 lite 1.2 GHz, 44 dB, 65 VAC 204/258 MHz diplex split

For specific configurations, please contact your sales representative.

Plug-in modules available for the DBC-1200 Lite

A wide range of plug-in modules and diplex filters are available to accommodate current and future network needs (65/85, 85/102, 204/258)

Item code	Legacy item no.	Description
19008513	DBDIP-01-W	DBx wide diplexer filter module 65/85 MHz
19008514	DBDIP-02-W	Diplex module 85/105 MHz DBE and strand mount amplifier
19008515	DBDIP-03-W	DBx wide diplexer filter module 204/258 MHz
19012967	DBDIP-05-5-W	85-102 MHz diplexer filter wide - 5 dB
19009966	DBDIP-05-W	Diplex module 85/102 MHz module wide
19005718	PI-SPL-2W-12G	Splitter 2 way, 3.5/3.5 dB, 1.2 GHz
19005719	PI-DC-08-12GO	Directional coupler, 8 dB, 1.2 GHz (output location)
19005720	PI-DC-12-12GO	Directional coupler, 12 dB, 1.2 GHz (output location)

For the auxiliary plug-in locations we can provide a range of plug-in components:

- JXP attenuators 1 inch values up to 30 dB
- Cable simulators 1.2 GHz (JXP style, 4mm thick)
- Cable equalisers 1 GHz and 1.2 GHz (JXP style, 4mm thick)
- Coaxial connectors and adapters

Chapter 1_Overview of the DBC-1200 Lite

The Technetix DBC-1200 Lite amplifier is a cost effective end-amplifier solution for locations where modularity is not a necessity. This is a single active output, non modular version of the DBC-1200 end amplifier which uses the same management software.

The amplifier provides reverse path transmission with a hybrid amplification stage.

Forward and return path attenuation can be adjusted with electronic attenuators. Electronic equalisers are available for forward and return path equalisation. Coax cable simulation is provided by a JXP plug-in device. This can be installed in the location AUX DS.

The DBC-1200 Lite has a highly efficient long-life switch-mode power supply available in local and remote powered version. The remote powered version supports both sine and block wave.



Benefits of the DBC-1200 Lite amplifier:

- Full digital control and set-up
- Improved intermodulation distortion performance - innovative GaN technology operates to 1218 MHz
- Energy efficient hybrid technology provides more gain without increasing the power consumption
- Technetix CPD Safe® technology and surge protection means fewer reported faults, improved customer service and a reduction in truck rolls.
- Based on the outstanding technology of the DBC-1200 amplifier
- Has very low power consumption while providing optimal performance.

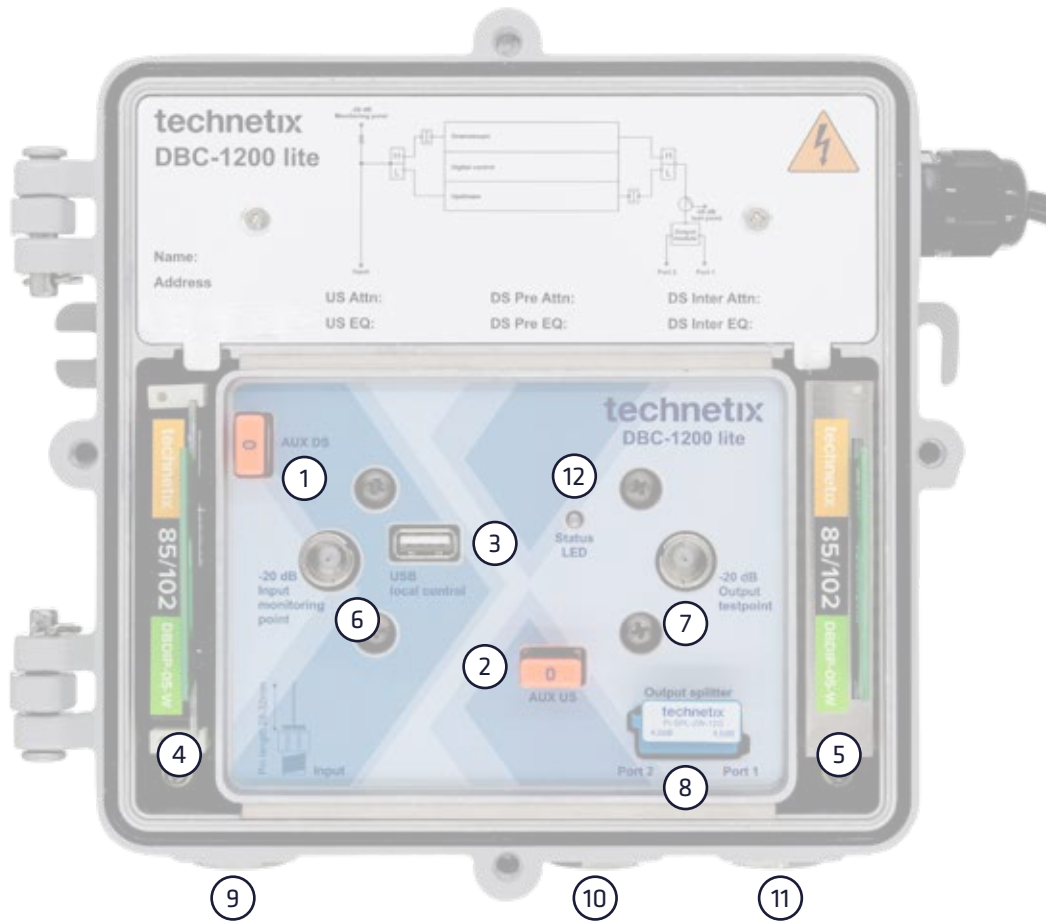

1	Downstream auxiliary plug-in location for JXP cables simulator or other application
2	Upstream auxiliary plug-in location for JXP attenuator/filter
3	USB A local control (configuring)
4	Input diplex filter 65/85, 85/102, 85/105 and 204/258 options
5	Screened output diplex filter 65/85, 85/102, 85/105 and 204/258 options
6	Input monitoring point -20 dB (omni-directional) F-male type
7	Output downstream -20 dB directional test point or upstream injection point -20 dB F-male type
8	Output splitter location: 2-way splitter PI-SPL-2W-12G; directional coupler tap 8 dB TX DC-8; tap 12 dB TX DC-12
9	Input RF port- PG11 thread with optional 5/8" reducing ring for 5/8" threaded connectors
10	Port 2 RF output port- PG11 thread with optional 5/8" reducing ring for 5/8" threaded connectors
11	Port 1 RF output port- PG11 thread with optional 5/8" reducing ring for 5/8" threaded connectors
12	Status LED (green or red)

Chapter 3_Installing the DBC-1200 Lite

3.1 Housing mounting

There are two options for mounting the DBC-1200 Lite amplifier:

1. Using integrated side brackets

Integrated side brackets can be used as shown below. The holes are suitable for bolts or screws with maximum diameter of 6 mm.

2. Rear mounted using integrated screw holes

For mounting directly onto a cabinet back panel, the rear 6 mm bolt holes (M6) can be used with two 6 mm threaded bolts (see following picture). Ensure when using this method of mounting that the bolt's threaded part is no longer than 10 mm in length when protruding through the back board that the amplifier will be mounted onto. The total length of the bolt to be used is 10mm + back board depth + washer depth. (M6 bolts are not delivered with the amplifier).

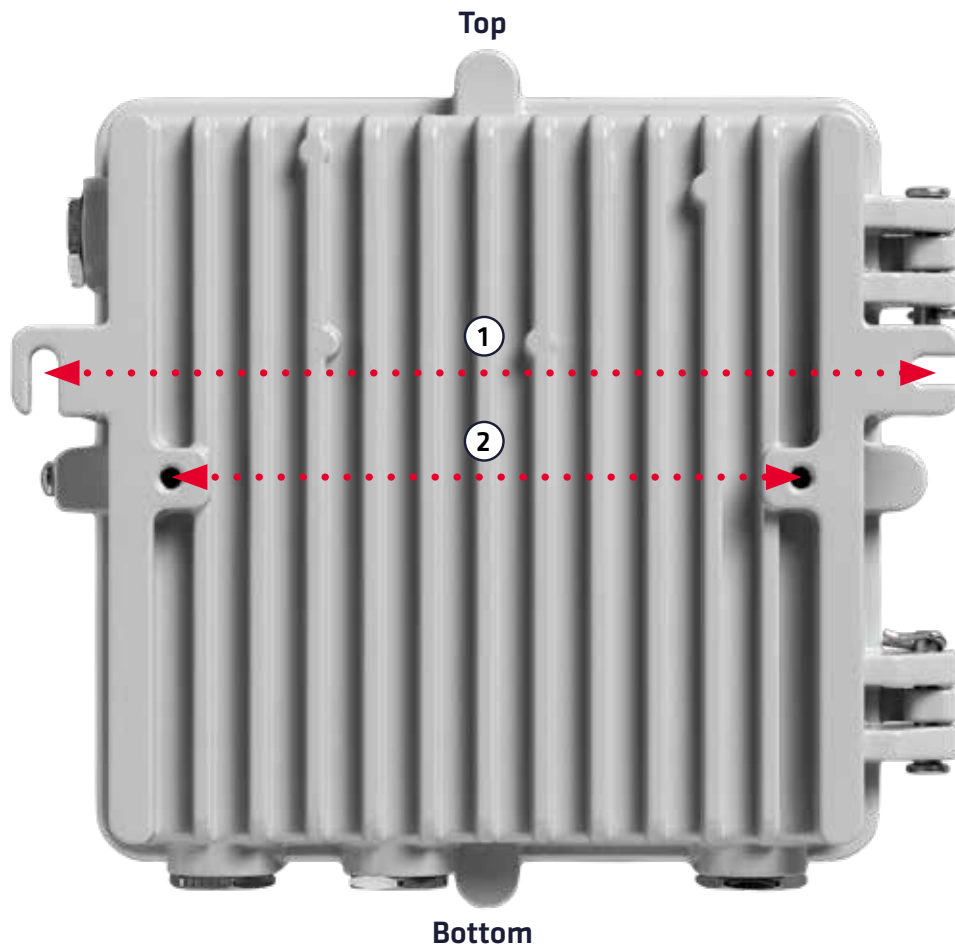

IMPORTANT: 1: Distance is 19.5 cm (including 0.25 cm - center point distance).
2: Distance is 14 cm (including 0.25 cm - center point distance).

3.2 Installing coaxial (RF ports)

The DBC-1200 Lite amplifier has one input RF port and two non power-passing RF output ports (Port 1 and Port 2).

All RF ports are PG11 threaded and are protected by plastic dust covers which must be removed before installing the coaxial connectors.

The amplifier can be factory equipped with PG11 to 5/8" adapter rings. Unused ports must be closed with an end plug or coaxial connector to ensure the DBC is water tight

Technetix double spring technology has the following advantages:

- BeCu spring contact with NiSn plating provides a secure, simple and repeatable installation
- Less sensitive to human error such as incorrect screw torque
- No cold flow (a screw will get loose over time)
- The spring will adjust to temperature changes while maintaining a perfect connection.

Installing the coaxial connectors

1. Cut the connector pins to a length between 28-32 mm (total) as shown on the drawing of the amplifier (*Fig. 1*).



IMPORTANT: the total pin length = pin length and connector thread length.

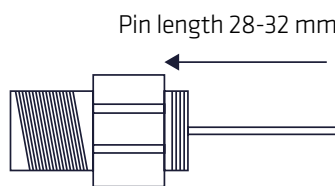

Fig. 1

2. Push the connector pin firmly in the port hole (*Fig. 2*). The amplifier is equipped with a double spring contact, so no screw is needed to fasten the coaxial connector pin.

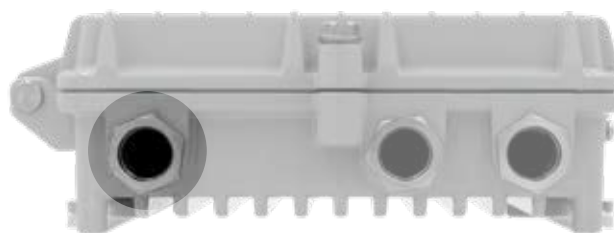

Fig. 2

3. Tighten the connectors into the housing in accordance with the connector manufacturer's specification. The recommended torque force for the PG-11-5/8 adapter ring is 15-16 Nm and 11-13 Nm for the coaxial connectors.

3.3 Closing amplifier lid

When closing the amplifier lid please first use a hex key to tighten the four hand bolts lightly in the following sequence:

- ① Right hand bolt ② Left hand bolt ③ Bottom bolt ④ Top bolt

Then, using a torque wrench set to a torque value of 6 Nm, go round again in sequence and tighten to the final torque setting.

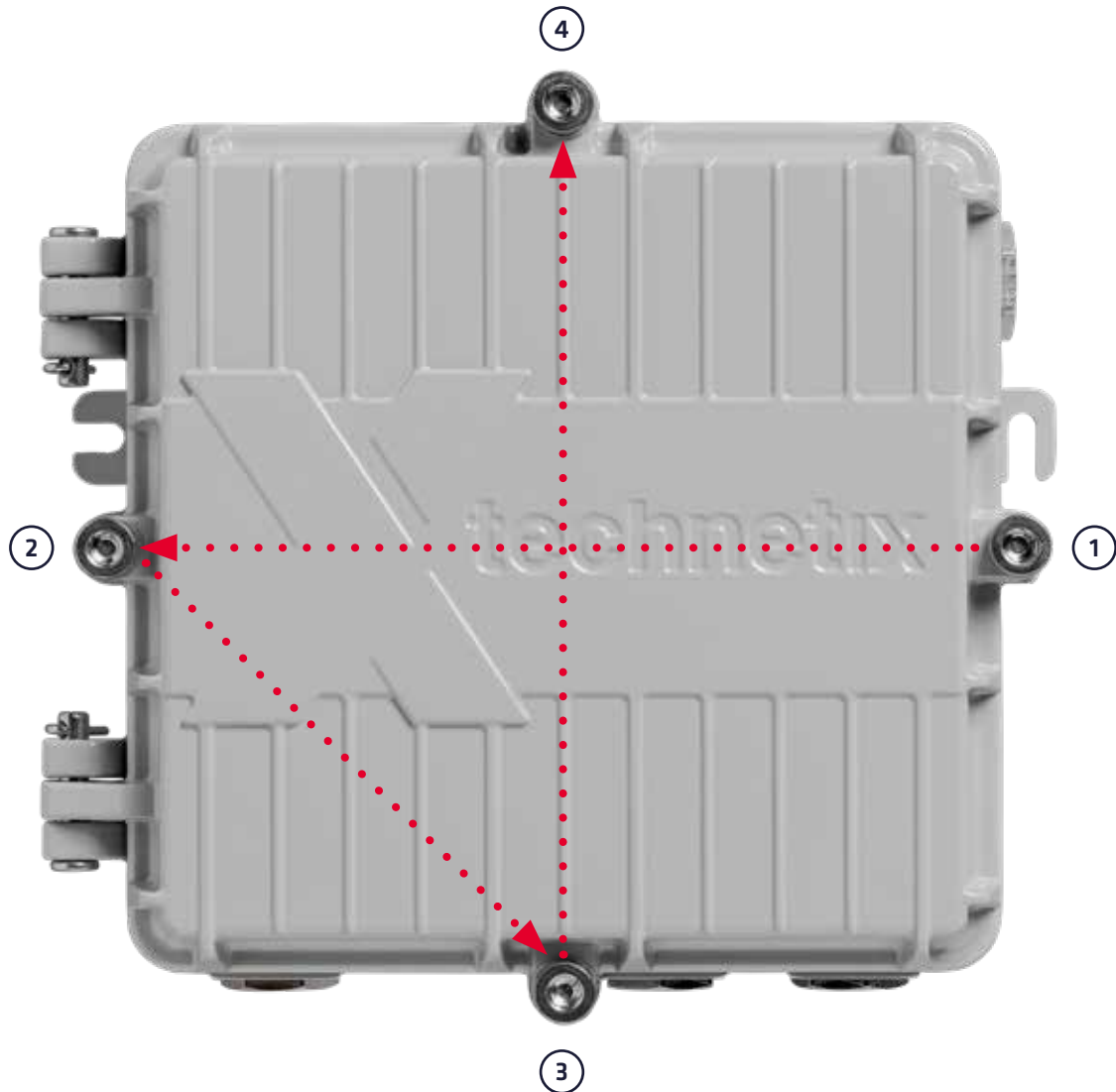

Following this sequence ensures:

1. The rubber gasket between the lid and the amplifier housing is sealed correctly, providing a sound, watertight seal to prevent water ingress.
2. There is a good RF seal between the RF gasket in the lid and the amplifier housing to prevent RF ingress/egress.
3. Good lid to housing contact for the dissipation of amplifier heat is required. The lid acts as a radiator when it is correctly secured, keeping the amplifier operating temperature down within parameters when installed as recommended.

3.4 Power supply

The DBC Lite-1200 has the following power supply options:

Local powering with 230VAC 50 Hz

Ordering description: DBC1200 LITE 230V AC

EU Plug 85/102 MHz

Input voltage should be: 110 VAC to 230 VAC

The 230V AC entry is at the top right of the amplifier.

The ground of the power plug has a direct connection to the ground of the amplifier. The socket ground is connected to the amplifier chassis. Also the coax cables will be connected to this ground.

Fuse on power supply is not field replaceable

Remote powering

Ordering description: DBC1200 LITE 65V AC

85/102 MHz

Input Voltage range: 35-65 VAC Sine Wave and 42-90 VAC Square wave

Fuse on power supply is not field replaceable



IMPORTANT: the power supply and fuses **are not** field replaceable.

3.5 Powering up the amplifier

1. Verify if the voltage present is in accordance with the amplifier specifications and the network design drawing calculation. Please make sure that the presence of input voltage is in accordance with amplifier specifications and network design drawing calculation.
2. The output ports should be connected first and the input port last as this will power the amplifier.
3. Connect the earthing/grounding wire (*Fig. 3*) (in accordance with local electrical installation regulations) on the right-hand side of the housing. The maximum diameter of the grounding wire is 3.8mm.

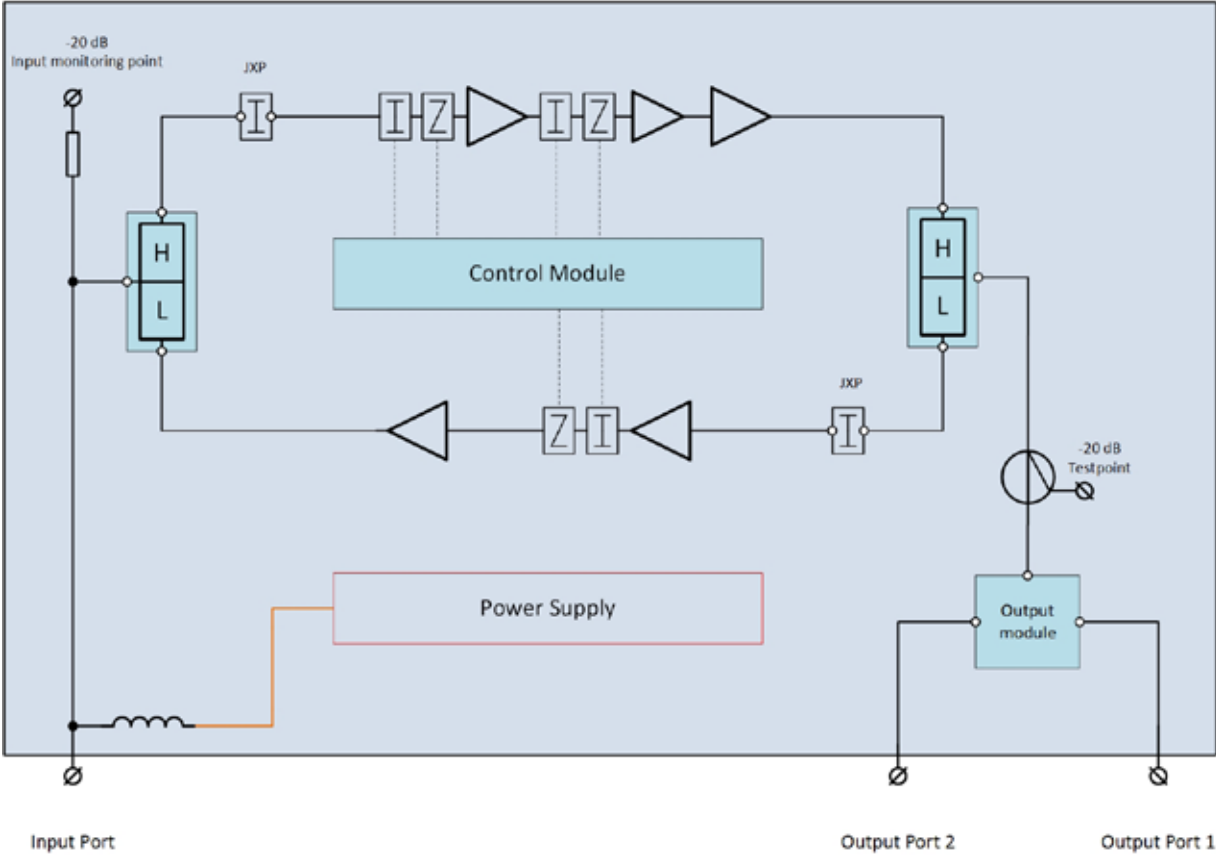

Fig. 3

4. Remove the AUX DS 0 dB attenuator temporarily to protect the amplifier from eventual high input RF levels. The attenuator can be re-installed once the electronic input and interstage attenuator have been configured to 10 dB or more (as a starting point).
5. Switch on the power and check that the status LED is steady green when power is present.

3.6 Block diagram and hardware configuration

Block diagram DBC-1200 Lite



3.7 Hardware and plug-in installation

Part numbers for compatible plug-ins are listed in a page 4 table of this user guide.



IMPORTANT: the power supply and fuses **are not** field replaceable.



Plug-ins

The AUX locations equipped with attenuator attenuators 0 dB as standard.

Removing this attenuator will interrupt the DS and US signals.

The attenuators can be replaced by 4mm thick JXP style cable simulators, an equaliser or filter.

Output splitter selector

Referring to the network design documentation, configure the output splitter by installing a 0 pad/attenuator into the last three of five holes on the right-hand side (to pass all RF into port 1) or the first three holes on the left-hand side (to pass all RF into port 2). Alternatively, install a relevant 2-way splitter or directional coupler.



IMAGE TO COME

Diplexer and diplexer upgrade

Referring to the network design documentation, verify that the diplexer has the correct band split.

Make sure that the output diplexer (right diplexer) has metal screening installed.

Output diplex shielding is required to meet the specified flatness specifications up to 1.2 GHz.

In the initial production of the DBC-1200 Lite the RF shield is glued to the diplexer. In later batches the shield is held in place by a plastic clip.

The glued diplexer can be removed in the field and re-used on a standard diplexer for a future diplex upgrade. *(Removal of a glued diplexer is described in a separate document).*

Output diplexer shield transfer for the DBC-1200 Lite

Screened diplexer

DBDIP-xx-W, a diplexer shielding with integrated clip, is available as an individual part (Fig. 4 and 5).

Please contact your sales representative



Fig. 4



Fig. 5



IMPORTANT: The diplexer must be removed with a Technetix diplexer extractor tool (Fig. 6 and 7), **do not** remove the diplexer PCB with pliers. Extraction **MUST** be done in a straight 90 degrees angle.



Fig. 6



Fig. 7



IMPORTANT: Ensure all unused amplifier ports are connected to a 75Ω terminated load.

3.8 Programming and alignment

Guidance

- The best downstream RF input level at the first amplifier stage is 72 dB μ V (12 dBmV) when all the channels are flat.
- The total amplifier DS gain (with 0 dB attenuation) is 44 dB.

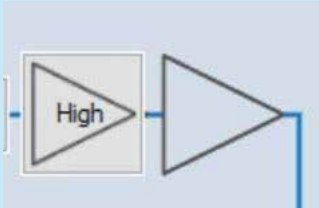

Hybrid in high power mode

The maximum RF output level loaded with 120 QAM channels 8 MHz is 112 dB μ V (52 dBmV) with 9 dB tilt.



IMPORTANT: If the output RF levels are above 109 dB μ V level **do not switch** to low power mode as this will result in BER and poor MER.

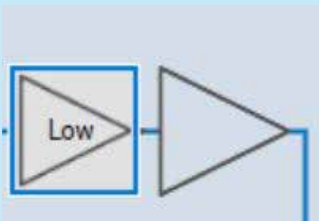

Hybrid in low power mode :

The maximum RF output level loaded with 120 QAM channels 8 MHz is 109 dB μ V (49 dBmV) with 9 dB tilt



IMPORTANT: When output RF levels are below 109 dB μ V level **you may switch** to low power mode as this will result in lower power consumption (2-3 watts less power usage).

Electronic setup of downstream and upstream

Using a laptop with the Technetix BLL software installed connect to the amplifier with the appropriate USB-A to USB-A lead. The amplifier must be powered before you can configure it. (Fig. 8)



Fig. 8

The BLL software will automatically connect to the DBC-1200 Lite amplifier. The amplifier type name and the schematic drawing with the current settings will appear at the top left of the application as shown below (Fig. 9).



Fig. 9



IMPORTANT: Ensure that the firmware version is v1.02. Please contact your local sales representative for assistance.

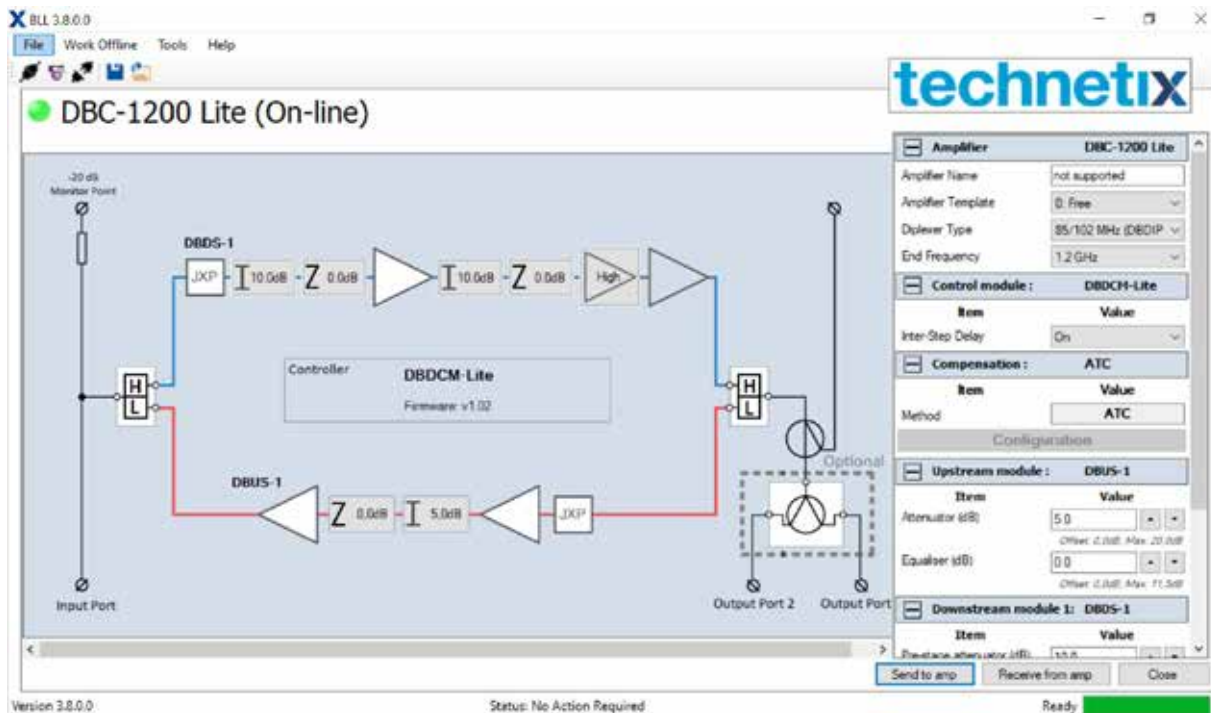

BLL page view - DBC-1200 Lite

1. Complete the diplexer type and end frequency

Amplifier template should be set to: Free (Fig. 10). The amplifier name field **is not supported** for the DBC-1200 Lite.

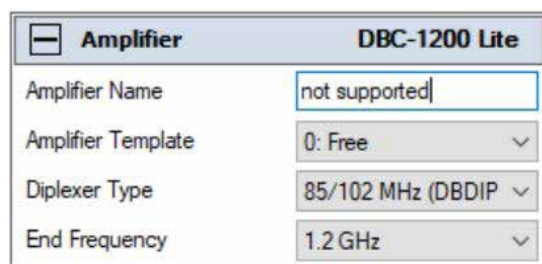

Fig. 10

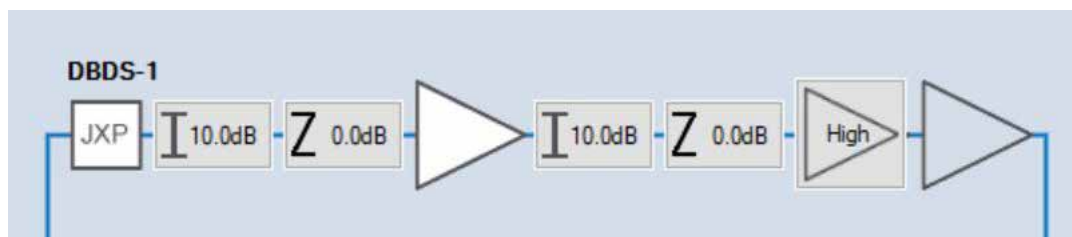

Fig. 11

To prevent overdriving the RF amplifier, select 10 dB for the pre and interstage attenuator and EQ settings to 0 dB (Fig. 11).

Once these values are set in the application, click on send to amp to set these values electronically.

Re-install the AUX-Ds 0 dB attenuator, the amplifier input will now be protected by the 10 dB attenuators.

2. Configuring downstream

In the example below the RF output level is 111 dB μ V with 9 dB tilt.

Connect the field meter to the output directional -20 dB test point and verify the input tilt. With the pre-stage equaliser set the RF output level to flat.

Read the RF channel level (+ 20 dB from test point)

For example: RF output port reading is 108 dB μ V

The calculated input RF port level is: 108dB μ V - 44 dB (gain) +10dB (pre-stage)+10 dB (interstage) = 84dB μ V

The input level at the first amplifier stage should be 72 dB μ V

Pre-stage attenuator should be set to: 84-72dB μ V= 12 dB

Adjust interstage EQ end interstage attenuator to obtain the desired RF output port level (Fig. 12).

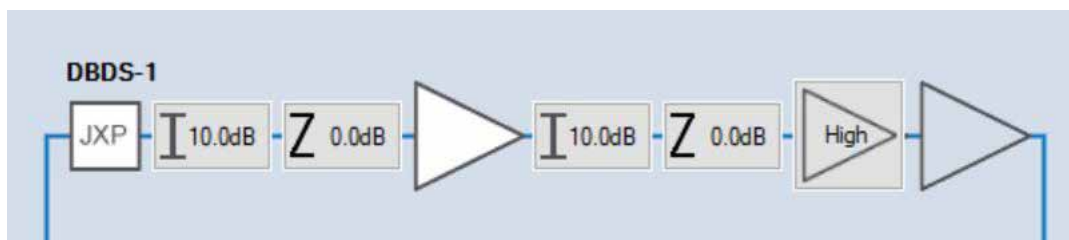

Fig. 12

3. Configuring upstream

Alignment with return path sweep set up equipment:

The return path gain of the amplifier is 25 dB (with 0 dB attenuator settings)

Set the return path sweep generator output to the required return path / upstream alignment level plus 20 dB to overcome the test point insertion losses.

Finally, adjust the amplifier upstream tilt and the attenuation in the BLL software (Fig. 13) to obtain a flat sweep response at the correct level for the upstream network design.

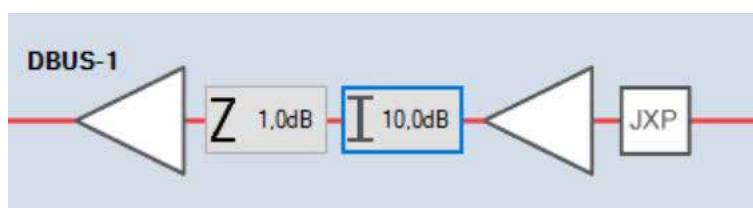

Fig. 13

If you would like further information on the content of this user manual, please contact:

Premton Bogaj
VP, HFC Networks
premton.bogaj@technetix.com
+31 318 58 59 59

© Copyright 2021 Technetix Group Limited. All rights reserved.

This document is for information only. Features and specifications are subject to change without notice. Technetix, the Technetix logo and certain other marks and logos are trade marks or registered trade marks of Technetix Group Limited in the UK and certain other countries. Other brand and company names are trade marks of their respective owners. Technetix protects its technology and designs by registering patents, trade marks and designs in Europe and certain other countries.